

Cenovnik spiro kanala i opreme - FON Inženjering D.O.O.



Spiro kolena:



Prečnik - Φ (mm)	Spiro kanal (€/m)	Spiro kolena:			Muf/nipli:	Cevna obujmica:	Brza diht spojnica:	Elastična konekcija:	€/kom:
		90°	45°	30°					
Ø100	2.31	4.52	3.17	2.71	1.06	2.10	7.00	2.74	€/kom:
Ø125	2.89	4.71	3.31	2.84	1.26	2.41	8.10	3.52	€/kom:
Ø150	3.81	6.94	4.86	4.17	1.26	2.95	9.10	3.52	€/kom:
Ø160	4.02	7.3	5.11	4.38	1.26	3.18	9.80	3.52	€/kom:
Ø180	4.74	8.77	6.13	5.25	1.42	3.40	9.88	4.00	€/kom:
Ø200	5.04	10.28	7.2	6.16	1.68	3.52	11.20	4.70	€/kom:
Ø225	5.64	10.68	7.48	6.31	1.68	3.91	11.66	4.70	€/kom:
Ø250	6.30	13.48	9.44	8.09	1.86	4.35	12.60	5.20	€/kom:
Ø280	6.81	15.28	10.7	9.17	1.96	4.83	13.60	5.48	€/kom:
Ø300	7.97	19.67	13.76	11.8	2.10	5.41	14.00	5.88	€/kom:
Ø315	8.96	18.88	13.21	11.33	3.47	6.02	14.00	9.72	€/kom:
Ø355	9.57	21.91	15.33	13.15	3.68	6.72	15.22	10.30	€/kom:
Ø400	11.38	25.84	18.09	15.51	4.31	7.69	16.10	12.06	€/kom:
Ø450	13.63	31.46	22.02	18.88	4.62	8.23	18.90	12.94	€/kom:
Ø500	14.11	37.08	25.96	22.23	5.25	9.20	20.30	14.70	€/kom:
Ø550	17.44	42.14	29.49	25.28	5.57	9.72	23.80	15.60	€/kom:
Ø560	18.94	42.69	29.88	25.62	5.57	10.37	23.80	15.60	€/kom:
Ø630	21.45	48.31	33.97	28.99	6.09	11.17	28.00	17.06	€/kom:
Ø710	28.29	65.16	45.61	39.1	6.83	12.59	32.90	19.12	€/kom:
Ø800	31.19	83.14	58.2	49.89	9.77	16.24	35.88	26.96	€/kom:
Ø900	36.86	110.1	77.07	66.07	12.60	20.86	39.90	35.28	€/kom:
Ø1000	42.74	157.29	110.1	94.37	14.70	24.72	46.00	41.17	€/kom:
Ø1250	54.86	222.45	155.72	133.48	19.95	30.80	53.00	55.94	€/kom:
Ø1400	60.06	243.8	170.66	146.31	23.10	37.80	66.00	64.00	€/kom:

Standardna dužina izrade spiro kanala je 3m ili 6m. Po zahtevu se rade i bilo koje druge dužine. Spiro kolena je moguće izraditi pod bilo kojim uglom. **Sve cene su navedene bez PDV-a.**



FON Inženjering D.O.O.

Ventilacija - klimatizacija - rekuperatori - integrisane toplotne pumpe

Kontakt: +381 18 4602 900, 4602 999

www.fon-ing.rs, email: foning@mts.rs

*Cenovnik ažuriran 25.01.2019.

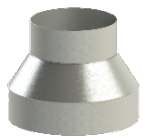

Redukcija - duga, centrična

Ø1000/1250	94.73	€/kom
Ø900/1000	77.62	€/kom
Ø800/900	64.71	€/kom
Ø710/800	53.92	€/kom
Ø710/630	44.94	€/kom
Ø630/560	36.62	€/kom
Ø560/500	30.33	€/kom
Ø500/450	24.37	€/kom
Ø450/400	20.14	€/kom
Ø400/355	18.15	€/kom
Ø355/315	15.52	€/kom
Ø315/250	12.79	€/kom
Ø355/250	14.48	€/kom
Ø250/200	11.08	€/kom
Ø200/160	10.00	€/kom
Ø160/125	8.95	€/kom

Napomena: Redukcije je moguće izraditi po izbornim prečnicima i dužinama

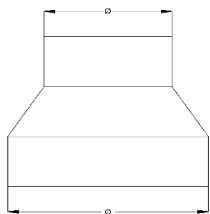

Φ(mm)	Sedlasti komad, presovan, centričan		
100/100	Sedlasti komad, presovan, centričan	2.85	€/kom
125/100	Sedlasti komad, presovan, centričan	2.95	€/kom
125/125	Sedlasti komad, presovan, centričan	3.45	€/kom
160/100	Sedlasti komad, presovan, centričan	3.13	€/kom
160/125	Sedlasti komad, presovan, centričan	3.88	€/kom
160/160	Sedlasti komad, presovan, centričan	4.81	€/kom
200/125	Sedlasti komad, presovan, centričan	3.78	€/kom
200/160	Sedlasti komad, presovan, centričan	4.80	€/kom
200/200	Sedlasti komad, presovan, centričan	6.46	€/kom
250/160	Sedlasti komad, presovan, centričan	5.24	€/kom
250/200	Sedlasti komad, presovan, centričan	5.78	€/kom
250/250	Sedlasti komad, presovan, centričan	8.05	€/kom
315/200	Sedlasti komad, presovan, centričan	7.04	€/kom
315/250	Sedlasti komad, presovan, centričan	9.66	€/kom
315/315	Sedlasti komad, presovan, centričan	12.86	€/kom
400/315	Sedlasti komad, presovan, centričan	12.86	€/kom



FON Inženjering D.O.O.

Ventilacija - klimatizacija - rekuperatori - integrisane toplotne pumpe

kontakt: +381 18 4602 900, 4602 999

www.fon-ing.rs, email: foning@mts.rs

*Cenovnik ažuriran 25.01.2019.

T račve - FON Inženjering D.O.O.

Φ(mm)	T račva, centrična	Cena(€/kom)			
100/100	T račva, centrična	5.50	450/400	T račva, centrična	34.84
125/100	T račva, centrična	5.89	500/280	T račva, centrična	33.37
125/125	T račva, centrična	6.18	500/315	T račva, centrična	35.38
150/100	T račva, centrična	6.43	500/450	T račva, centrična	39.63
160/100	T račva, centrična	6.81	500/500	T račva, centrična	49.32
160/125	T račva, centrična	6.82	630/500	T račva, centrična	52.23
160/160	T račva, centrična	7.01	630/630	T račva, centrična	56.99
180/100	T račva, centrična	8.35	710/630	T račva, centrična	63.00
180/125	T račva, centrična	6.95	710/710	T račva, centrična	66.36
200/100	T račva, centrična	8.00	800/800	T račva, centrična	74.76
200/125	T račva, centrična	7.29	900/900	T račva, centrična	76.44
200/160	T račva, centrična	8.84	900/800	T račva, centrična	90.99
200/200	T račva, centrična	9.76	1000/900	T račva, centrična	102.46
250/160	T račva, centrična	11.49			
250/200	T račva, centrična	13.52			
250/250	T račva, centrična	17.10			
315/200	T račva, centrična	15.56			
315/250	T račva, centrična	17.87			
315/315	T račva, centrična	20.29			
355/280	T račva, centrična	25.75			
400/250	T račva, centrična	24.49			
400/300	T račva, centrična	25.20			
400/315	T račva, centrična	26.24			
400/400	T račva, centrična	34.11			
450/250	T račva, centrična	28.16			
450/280	T račva, centrična	29.25			
450/355	T račva, centrična	36.85			



FON Inženjering D.O.O.

Ventilacija - klimatizacija - rekuperatori - integrisane toplotne pumpe

kontakt: +381 18 4602 900, 4602 999

www.fon-ing.rs, email: foning@mts.rs

*Cenovnik ažuriran 25.01.2019.

Kose račve - FON Inženjering D.O.O.

Φ(mm)	Kosa račva	Cena(€/kom)	450/400	Kosa račva - 45°	
100/100	Kosa račva - 45°	8.94	500/280	Kosa račva - 45°	54.24
125/100	Kosa račva - 45°	9.58	500/315	Kosa račva - 45°	57.49
125/125	Kosa račva - 45°	10.05	500/450	Kosa račva - 45°	64.40
150/100	Kosa račva - 45°	10.45	500/500	Kosa račva - 45°	80.15
160/100	Kosa račva - 45°	11.08	630/500	Kosa račva - 45°	84.88
160/125	Kosa račva - 45°	11.08	630/630	Kosa račva - 45°	92.61
160/160	Kosa račva - 45°	11.40	710/630	Kosa račva - 45°	102.37
180/100	Kosa račva - 45°	13.57	710/710	Kosa račva - 45°	107.83
180/125	Kosa račva - 45°	11.30	800/800	Kosa račva - 45°	121.49
200/100	Kosa račva - 45°	13.00	900/900	Kosa račva - 45°	124.21
200/125	Kosa račva - 45°	11.86	900/800	Kosa račva - 45°	147.86
200/160	Kosa račva - 45°	15.52	1000/900	Kosa račva - 45°	166.50
200/200	Kosa račva - 45°	15.86			
250/160	Kosa račva - 45°	18.68			
250/200	Kosa račva - 45°	21.98			
250/250	Kosa račva - 45°	27.79			
315/200	Kosa račva - 45°	25.94			
315/250	Kosa račva - 45°	29.04			
315/315	Kosa račva - 45°	32.97			
355/280	Kosa račva - 45°	41.85			
400/250	Kosa račva - 45°	34.92			
400/300	Kosa račva - 45°	40.95			
400/315	Kosa račva - 45°	42.64			
400/400	Kosa račva - 45°	56.71			
450/250	Kosa račva - 45°	45.76			
450/280	Kosa račva - 45°	47.21			
450/355	Kosa račva - 45°	54.44			



FON Inženjering D.O.O.

Ventilacija - klimatizacija - rekuperatori - integrisane toplotne pumpe

kontakt: +381 18 4602 900, 4602 999

www.fon-ing.rs, email: foning@mts.rs

*Cenovnik ažuriran 25.01.2019.

Φ(mm)	Cena	(€/kom)
125	13.80	(€/kom)
150	17.17	(€/kom)
160	17.50	(€/kom)
180	18.66	(€/kom)
200	19.43	(€/kom)
225	20.16	(€/kom)
250	20.91	(€/kom)
280	23.93	(€/kom)
300	23.99	(€/kom)
315	25.05	(€/kom)
355	28.53	(€/kom)
400	31.73	(€/kom)
450	35.78	(€/kom)
500	39.99	(€/kom)
550	44.26	(€/kom)
600	52.87	(€/kom)
630	53.99	(€/kom)



Pravougaoni kanali i fazonski elementi - FON Inženjering D.O.O.

Debljina lima(mm)	0.5				0.8	
	400	600	800-1000	1200-1400	1600-2200	2400
Obim kanala	13.15	12.23	11.50 - 11.78	11.33 - 16.41	16 - 16.30	16
Cena(€/m)	2.10	1.85	1.75	1.75	1.75	1.70
Cena po €/kg						



Pravougaone vazdušne instalacije proizvode se od pocinkovanog lima debljine 0.5mm, 0.8mm, 1.0mm i 1.25mm, na standardnu dužinu od 1250mm za prave deonice. Po zahtevu se proizvode instalacije na dužinu do 2000mm, kao i debljine lima 1.50mm i deblje, kao i crni kanali za odimljavanje.

Prigušivači buke - FON Inženjering D.O.O.

Tip:	Dimenzija(mm):	Cena(€/kom)	broj kulisa na 50mm(standardno)
IAA - 200	400x200	102.9	3 + 2
IAA - 225	500x250	105	4 + 2
IAA - 250	500x300	117.6	5 + 2
IAA - 315	600x350	161.7	5 + 2
IAA - 355	700x400	173.25	6 + 2
IAA - 400	800x500	194.25	3 + 2
IAA - 450	1000x500	210	4 + 2

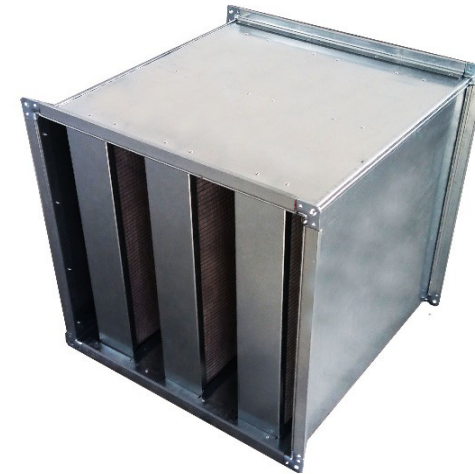

FON Inženjering D.O.O.

Ventilacija - klimatizacija - rekuperatori - integrisane toplotne pumpe

kontakt: +381 18 4602 900, 4602 999

www.fon-ing.rs, email: foning@mts.rs

*Cenovnik ažuriran 25.01.2019.

Cevni prigušivači buke CPB

Tip:	A(mm):	B(mm):	L(mm):	Cena(€):
CPB 100	100	200	900	56
CPB 125	125	225	900	61
CPB 150	150	250	900	68
CPB 160	160	260	900	74
CPB 180	180	280	900	80
CPB 200	200	300	900	88
CPB 250	250	350	900	106
CPB 280	280	380	1000	110
CPB 315	315	415	1000	124
CPB 355	355	455	1000	176
CPB 400	400	500	1050	206
CPB 450	450	550	1050	216
CPB 500	500	600	1100	228
CPB 560	560	660	1100	248

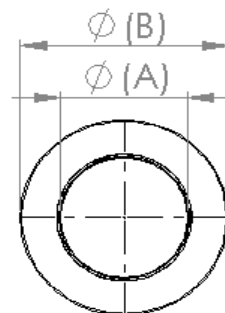
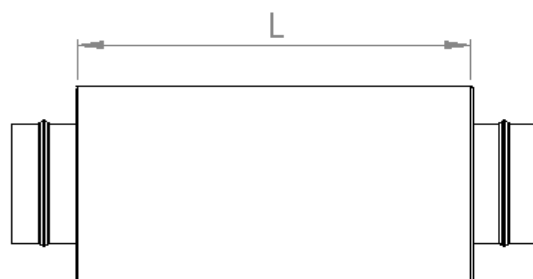

Prelazni komadi Ax B/Ø - KPK

A x B (mm)	Ø	H	(€/kom)
300 x 200	250	300	28.8
400 x 200	250	300	39.2
500 x 250	250	300	50.4
500 x 300	300	350	62.4
500 x 300	355	350	64.0
600 x 300	315	350	73.6
600 x 400	400	400	96.0
600 x 500	450	400	106.4
600 x 600	500	500	119.0
232 x 200	200	150	20.0
232 x 261	200	150	24.0
298 x 261	250	200	35.0
291 x 265	250	200	35.0
331 x 262	250	250	42.0
331 x 262	315	300	44.0
342 x 309	315	300	53.0
395 x 342	315	300	63.0
395 x 342	355	300	63.0
405 x 474	400	400	85.5

Sve mere prikazane na skici mogu biti urađene po odabiru. Takođe, prelazni elementi mogu biti ekscentrični. Prirubnice su najčešće MEC20 ili MEC30 profili, a po zahtevu mogu biti i drugi tipovi.

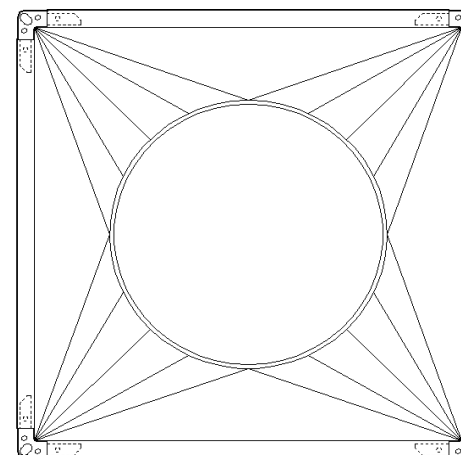
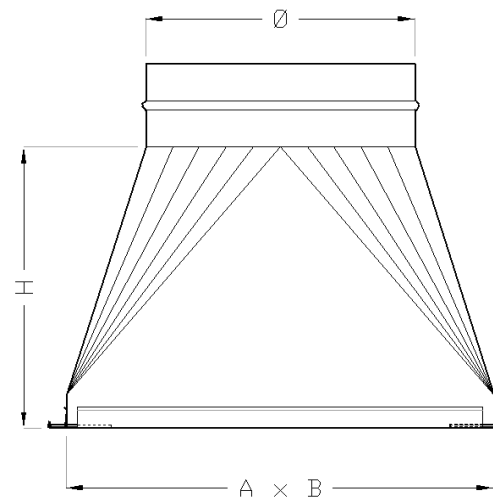

FON Inženjering D.O.O.

Ventilacija - klimatizacija - rekuperatori - integrisane toplotne pumpe

kontakt: +381 18 4602 900, 4602 999

www.fon-ing.rs, email: foning@mts.rs

*Cenovnik ažuriran 25.01.2019.